

SMALL

ISTRUZIONI DI MONTAGGIO



N.B. 1: Nelle istruzioni di montaggio verranno usate le seguenti terminologie:

- PARETE ANTERIORE: parete in legno frontale, guardando la casetta frontalmente;
- PARETE SINISTRA: parete in legno sinistra, guardando la casetta frontalmente;
- PARETE DESTRA: parete in legno destra, guardando la casetta frontalmente;
- PARETE POSTERIORE: parete in legno posteriore, guardando la casetta frontalmente.

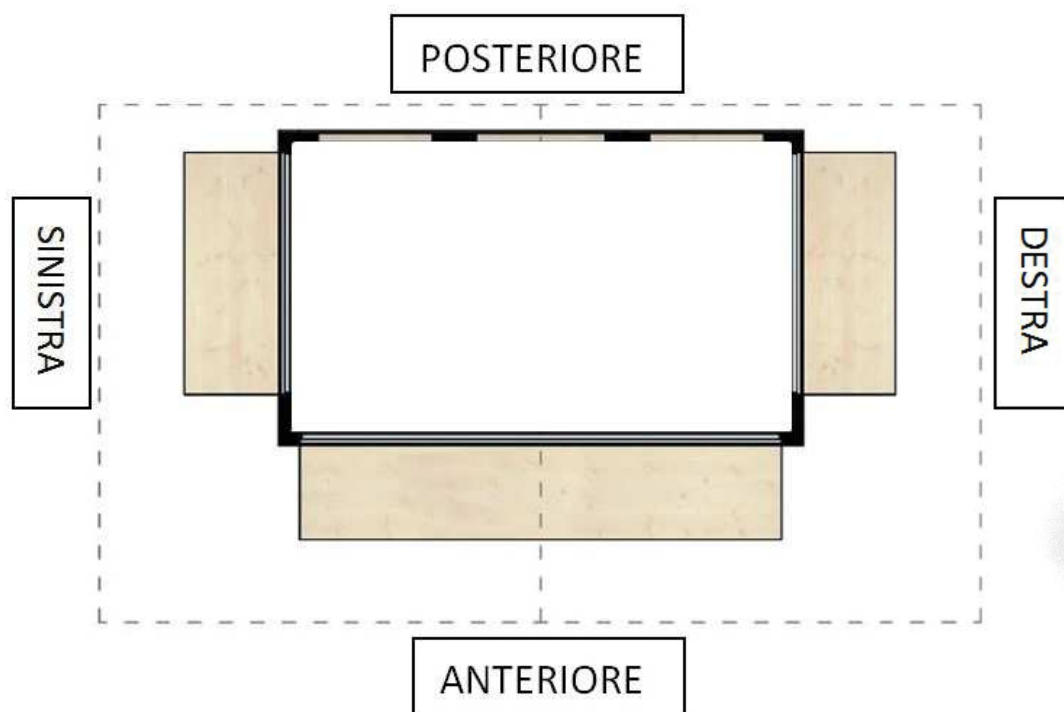

N.B. 2: Durante tutte le operazioni elencate di seguito vanno rispettate le normative vigenti, in modo particolare quelle riguardanti la sicurezza, con l'utilizzo di apposite attrezzature che prevedono di evitare o limitare i rischi per le persone e danni a cose. Si consiglia di fare attenzione ed indossare dispositivi di sicurezza personale (guanti, scarpe antifuoristrada, ecc) e l'utilizzo di due scale, specialmente durante il montaggio della copertura.

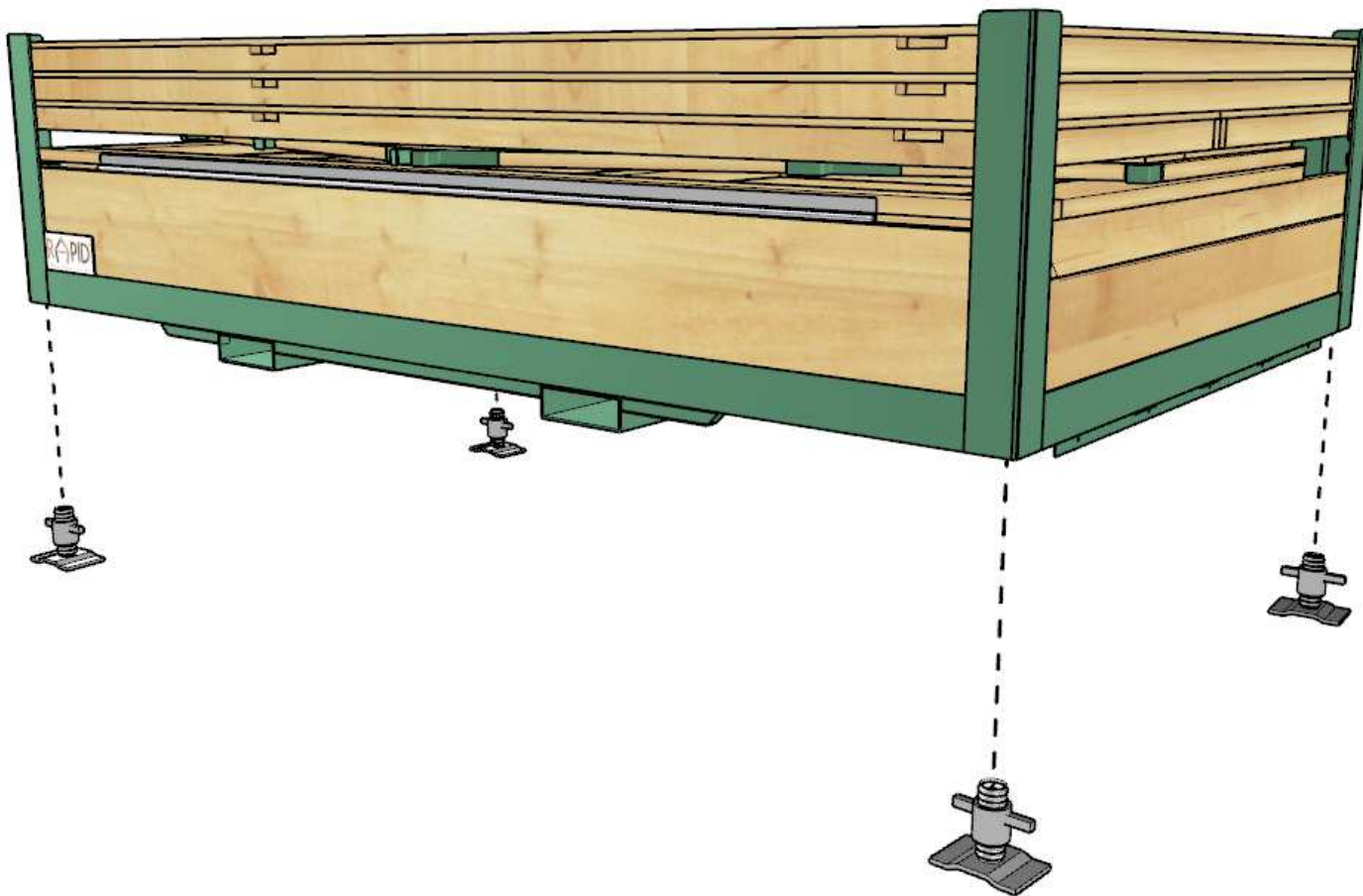

POSIZIONARE LA CASSETTA NELL'AREA DESIDERATA UTILIZZANDO UN CARRELLO ELEVATORE, TENENDO CONTO DEL MASSIMO INGOMBRO CHE ESSA OCCUPERA' A MONTAGGIO ULTIMATO, COMPRESI LE FALDE DELLA COPERTURA. PRELEVARE LE 4 BASETTE REGOLABILI E POSIZIONARLE, DOPO AVERLE REGOLATE IN ALTEZZA, IN CORRISPONDENZA DEI 4 ANGOLI DELLA BASE METALLICA, NEI RISPETTIVI ALLOGGIAMENTI. UNA VOLTA CHE LA CASSETTA E' STATA POSIZIONATA E' COMUNQUE POSSIBILE ESEGUIRE UN'ULTERIORE REGOLAZIONE MUNENDOSI DI UNA LEVA E FACENDO RUOTARE IL REGISTRO DELLA BASETTA FINO ALLA MISURA DESIDERATA. QUALORA IL FONDO FOSSE GIA PERFETTAMENTE ORIZZONTALE, NON E' RICHiesto L'UTILIZZO DELLE BASETTE REGOLABILI.

1



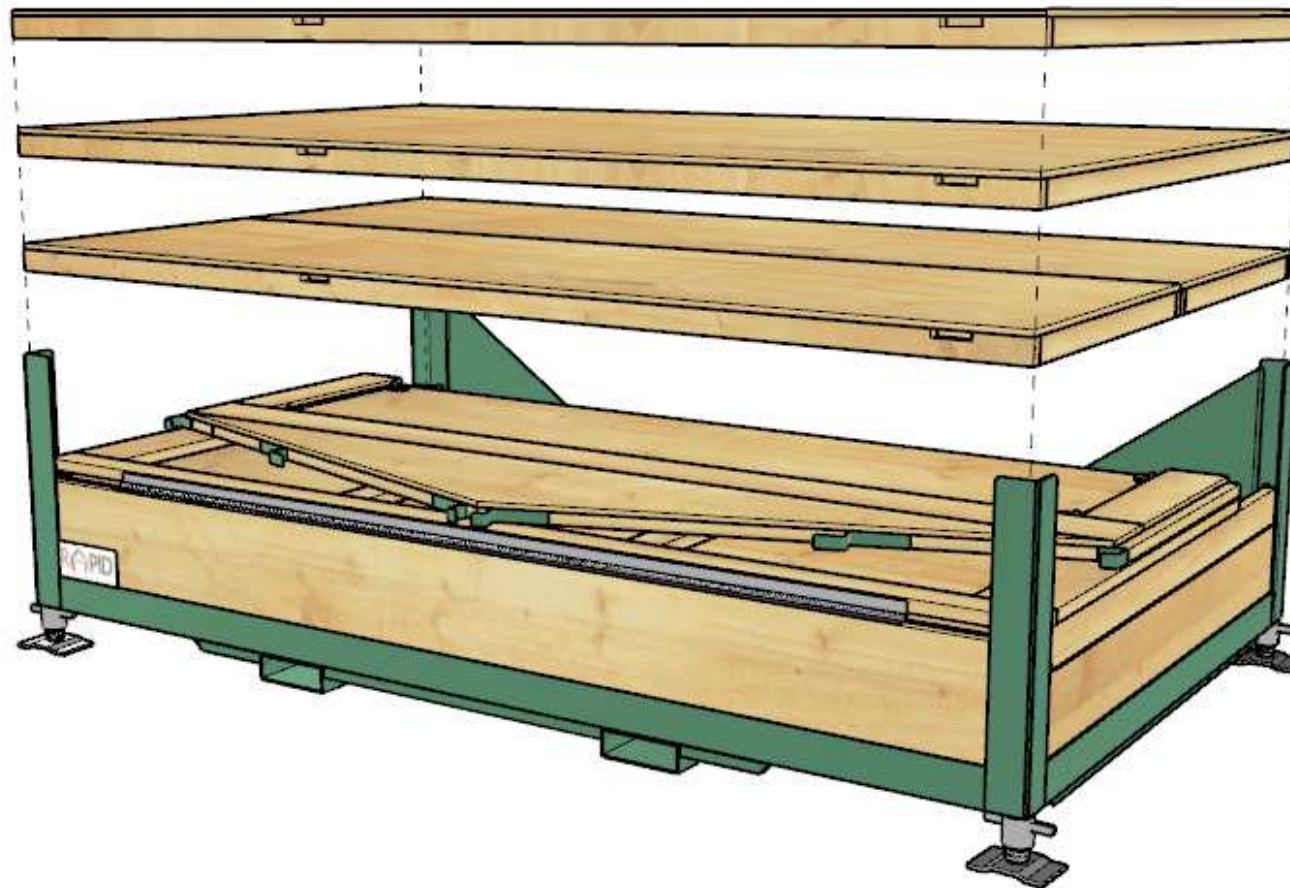

RIMUOVERE I 4 COMPONENTI DELLA COPERTURA, DUE FALDE GRANDI E DUE PICCOLE, COME MOSTRATO IN FIGURA. POSIZIONARLE NELLE IMMEDIATE VICINANZE. RIMUOVERE INOLTRE IL TELO DI COPERTURA IN PVC IN DOTAZIONE CHE SERVIRÀ PER ULTIMARE IL MONTAGGIO DELLA CASSETTA. SONO RICHIESTE DUE PERSONE PER QUEST'OPERAZIONE.

2



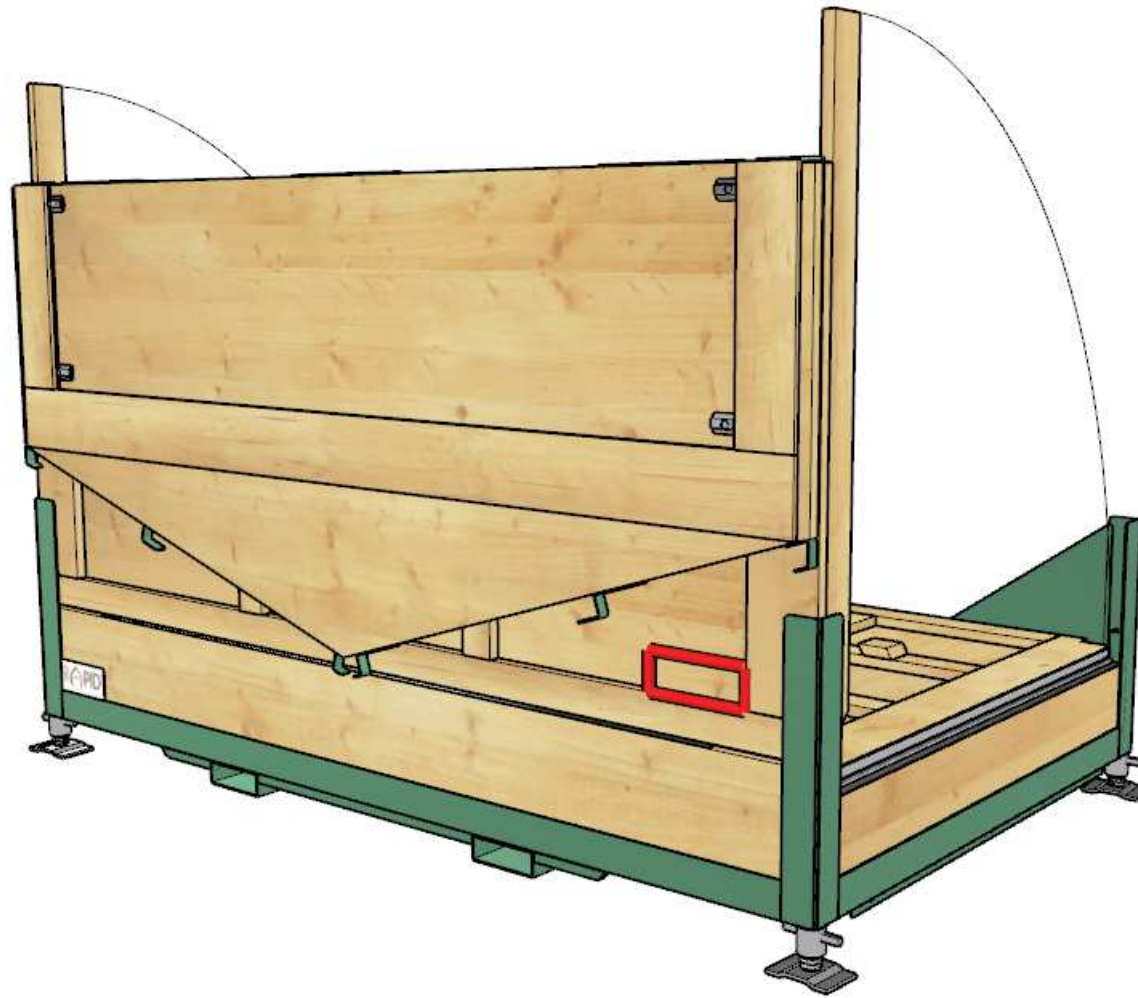

IMPUGNANDO LA PARETE FRONTALE DA ENTRAMBI I LATI, RUOTARLA DI 90° FINCHE' ESSA NON RAGGIUNGE UNA POSIZIONE VERTICALE. LE VITI IN DOTAZIONE, NECESSARIE AL SUCCESSIVO FISSAGGIO DELLA PARETE FRONTALE CON QUELLA LATERALE DESTRA E SINISTRA, SI TROVANO NELL'ALLOGGIAMENTO RAFFIGURATO DAL RIQUADRO ROSSO, NELLA PARTE IN BASSO A DESTRA DELLA PARETE FRONTALE. MANTENERE LA PARETE IN POSIZIONE VERTICALE FINO AL COMPIMENTO DELLA FASE SUCCESSIVA. SONO RICHIESTE DUE PERSONE PER IL COMPLETAMENTO DI QUEST'OPERAZIONE.

3



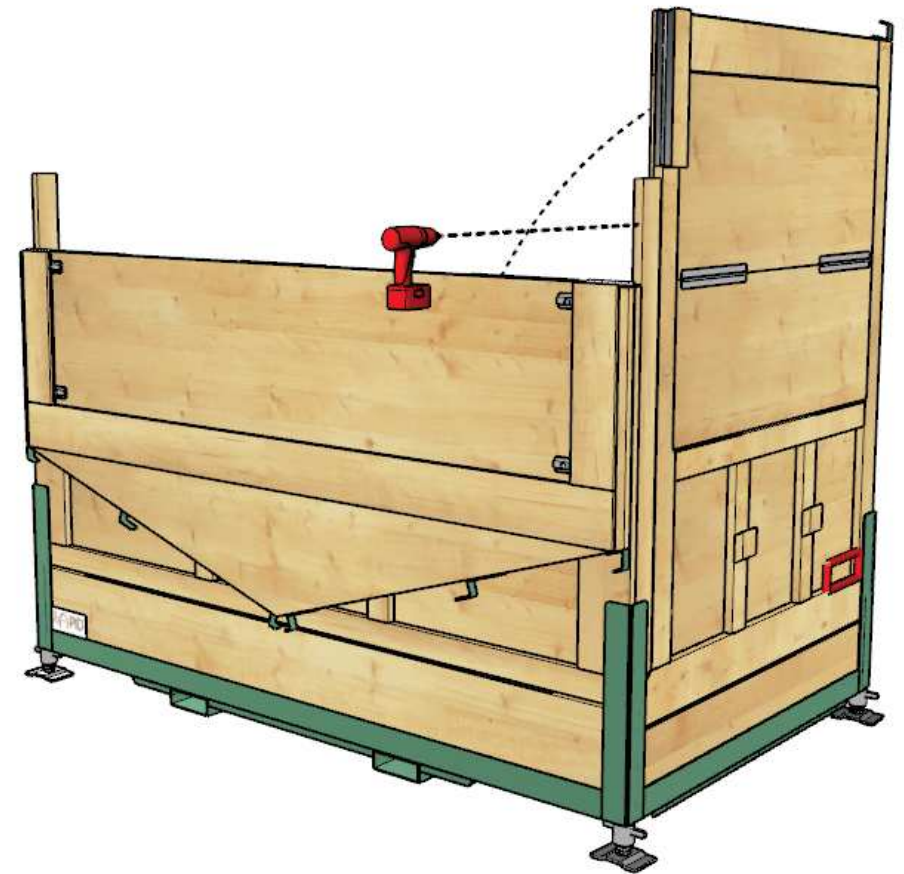
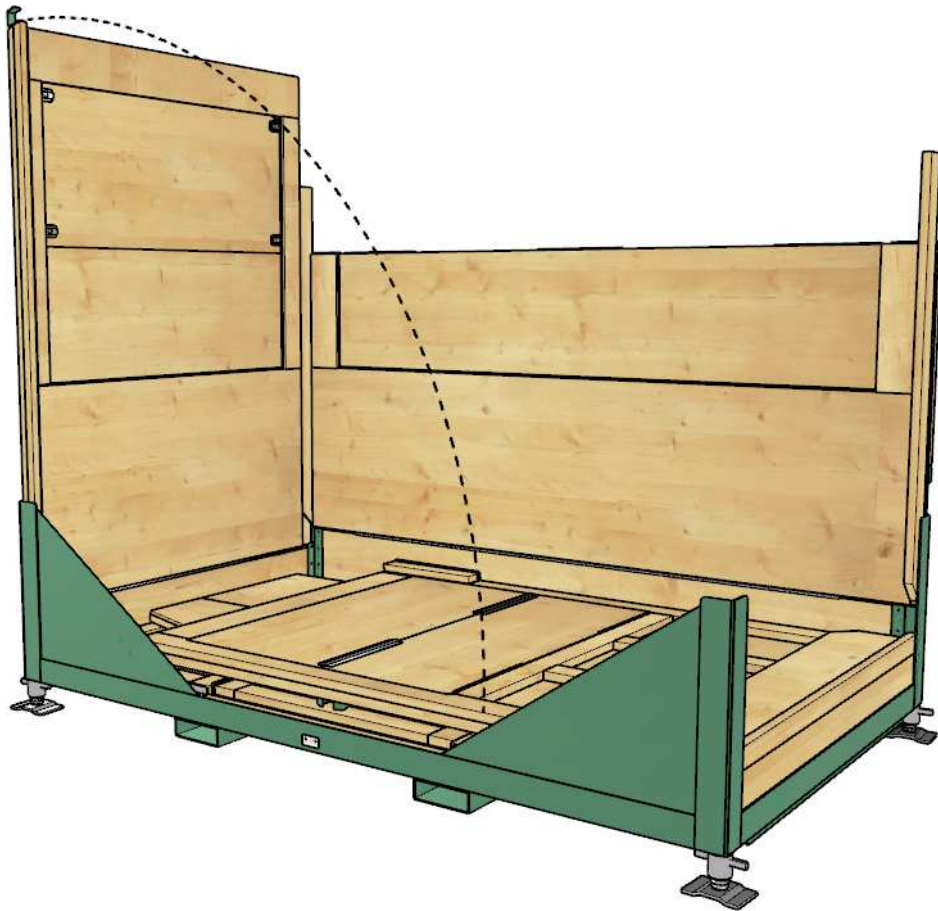

MENTRE UN OPERATORE MANTIENE IN POSIZIONE VERTICALE LA PARETE FRONTALE DAL LATO SINISTRO (GUARDANDO FRONTALMENTE LA CASSETTA), IL SECONDO PUO' PORTARSI SUL LATO POSTERIORE, AFFERARE NELLA PARTE ALTA LA PARETE LATERALE DESTRA (GUARDANDO FRONTALMENTE LA CASSETTA) E FARLA RUOTARE IN POSIZIONE VERTICALE COME MOSTRATO NELLA FIGURA SINISTRA. UNA VOLTA CHE LE DUE PARETI SONO ALLINEATE TRA DI LORO, E' POSSIBILE FISSARLE UTILIZZANDO UNA DELLE DUE VITI PIU' LUNGHE IN DOTAZIONE, MEDIANTE IL FORO GIA' PREDISPOSTO, COME MOSTRATO NELL'IMMAGINE DI DESTRA. SULLA PARETE LATERALE DESTRA, NELLA PARTE BASSA (RAFFIGURATA DAL RETTANGOLO ROSSO NELL'IMMAGINE DI DESTRA) ,SONO ALLOGGiate LE VITI NECESSARIE AL FISSAGGIO DELLA PARETE LATERALE DESTRA CON QUELLA POSTERIORE, CHE AVVERRA' NELLE FASI SUCCESSIVE.

4



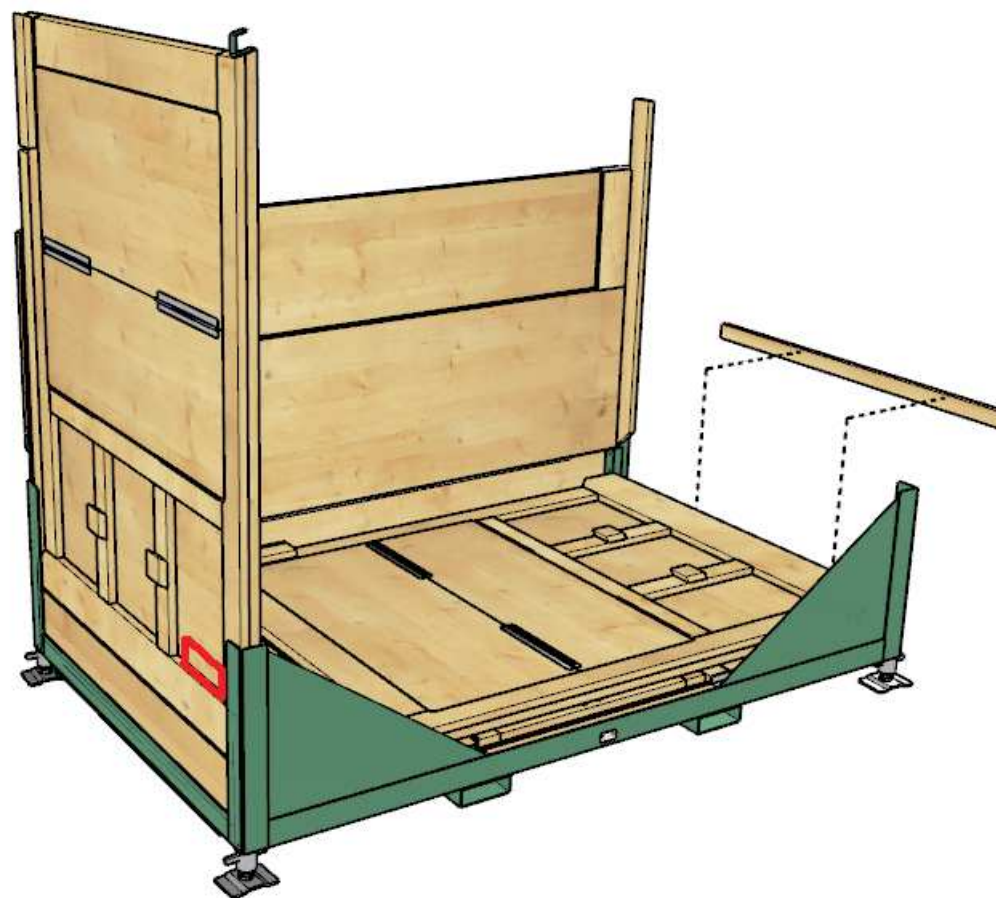

PER CONTINUARE LE OPERAZIONI DI MONTAGGIO E' NECESSARIO RIMUOVERE, SULLA PARETE SINISTRA (GUARDANDO FRONTALMENTE LA CASSETTA), IL COMPONENTE IN LEGNO COME MOSTRATO IN FIGURA. ESSO PUO' ESSERE RIPOSTO IN UNO DEI DUE FORI UTILIZZATI PER MOVIMENTARE LA CASSETTA CON IL CARRELLO ELEVATORE, POSTI SOTTO ALLA BASE METALLICA. QUESTO COMPONENTE E' INDISPENSABILE NELLA FASE DI SMONTAGGIO E CHIUSURA, EVITANDO COSI' DI DANNEGGIARE IN MANIERA IRREVERSIBILE IL PRODOTTO. PRELEVARE INOLTRE LE DUE VITI NECESSARIE AL FISSAGGIO TRA LA PARETE LATERALE SINISTRA E QUELLA POSTERIORE, ALLOGGiate NELLA PARTE BASSA, COME MOSTRATO IN FIGURA DAL RETTANGOLO ROSSO.

5



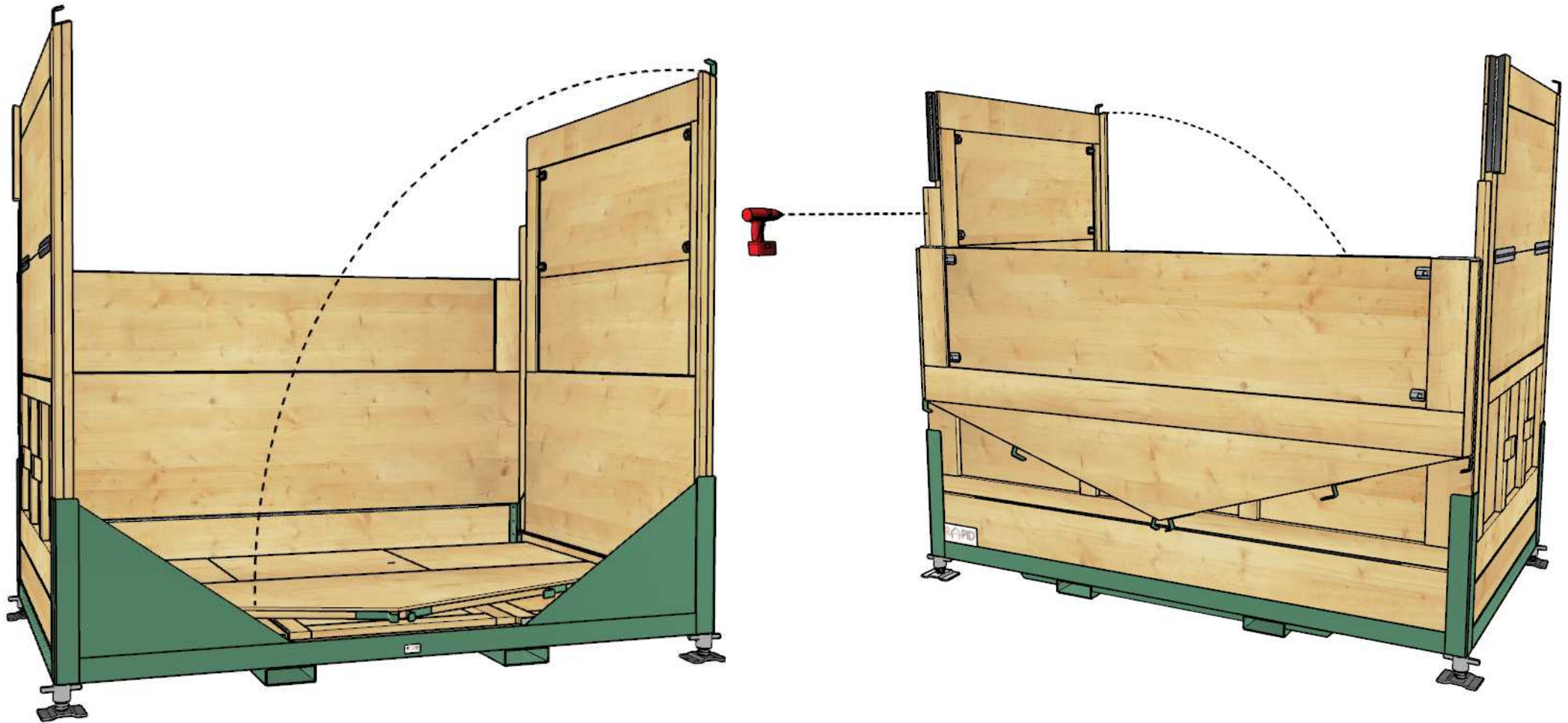

PER PROCEDERE ALLA ROTAZIONE DELLA PARETE LATERALE SINISTRA E' NECESSARIO CHE UNO DEI DUE OPERATORI SI PORTI SUL LATO ANTERIORE DELLA CASSETTA, L'ALTRO SU QUELLO POSTERIORE. QUEST'ULTIMO DEVE AFFERRARE LA PARETE LATERALE NELLA PARTE ALTA E FARLA RUOTARE FINO A CHE NON RAGGIUNGE LA POSIZIONE VERTICALE, ANALOGAMENTE A QUANTO FATTO PER LA PARETE DESTRA. UNA VOLTA CHE QUESTA E' ALLINEATA CON LA PARETE FRONTALE E' POSSIBILE FISSARLE TRA DI LORO, UTILIZZANDO LA VITE PIU' LUNGA RIMANENTE (DI CUI AL PUNTO 3) AVVITANDOLA NEL FORO PREDISPOSTO SULLA PARETE FRONTALE, COME MOSTRATO IN FIGURA.

6



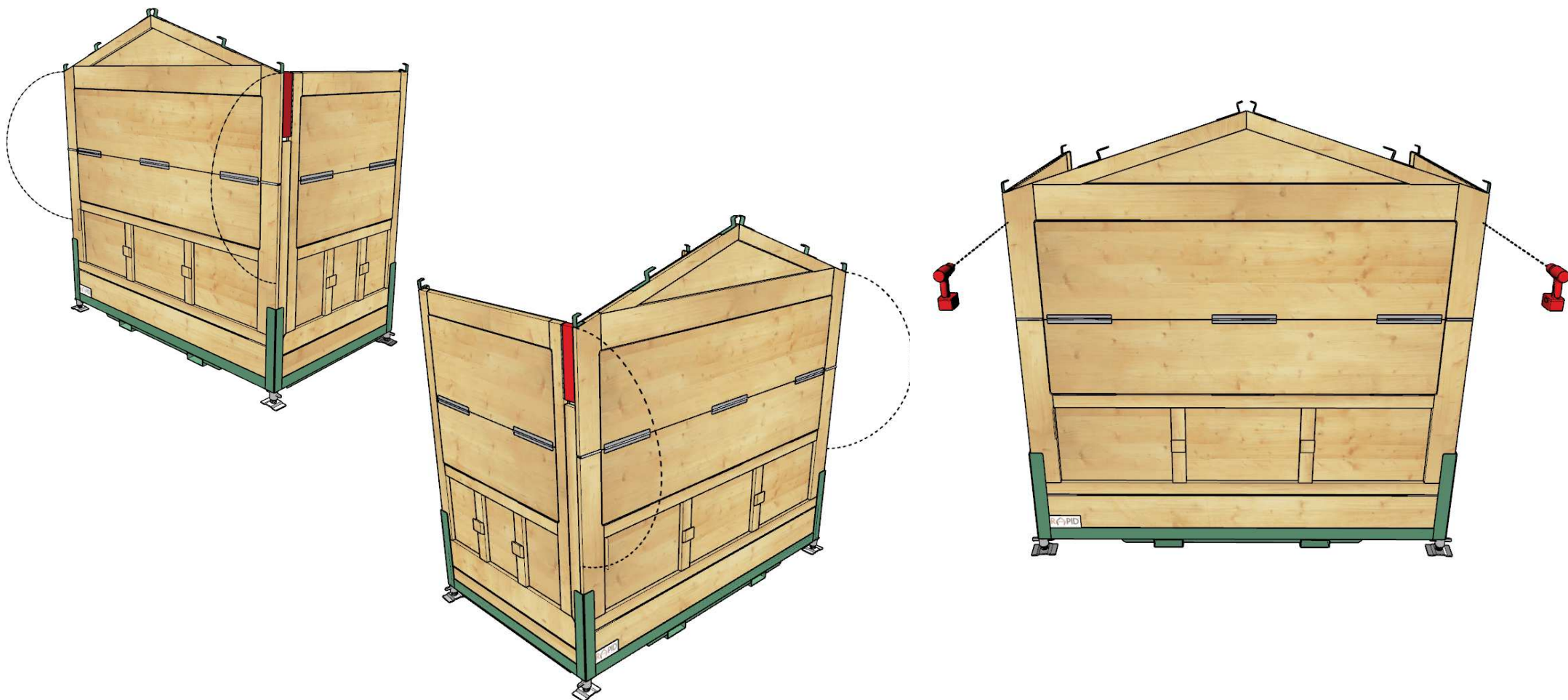

PER PROCEDERE ALLA ROTAZIONE DELLA META' ALTA DELLA PARETE FRONTALE E' PRIMA NECESSARIO FAR RUOTARE DI 180° LE DUE ALETTE FISSATE SULLE PARETI LATERALI, RAFFIGURATE IN ROSSO NELL'IMMAGINE DI SINISTRA, ALLINEANDOLE CON IL FILO ESTERNO DELLA PARTE BASSA DELLA PARETE FRONTALE GIA' FISSATA PRECEDENTEMENTE. SOLO DOPO QUESTA FASE E' POSSIBILE IMPUGNARE LA META' ALTA DELLA PARETE FRONTALE DAL LATO DESTRO E DAL LATO SINISTRO, SONO RICHIESTI DUE OPERATORI IN QUESTA FASE, E FARLA RUOTARE IN POSIZIONE VERTICALE. MENTRE UNO DEI DUE OPERATORI LA MANTIENE IN POSIZIONE, IL SECONDO PUO' FISSARLA NEI FORI PREDISPOSTI MEDIANTE LE DUE VITI PIU' CORTE RIMANENTI, COME MOSTRATO NELL'IMMAGINE DI DESTRA.

7



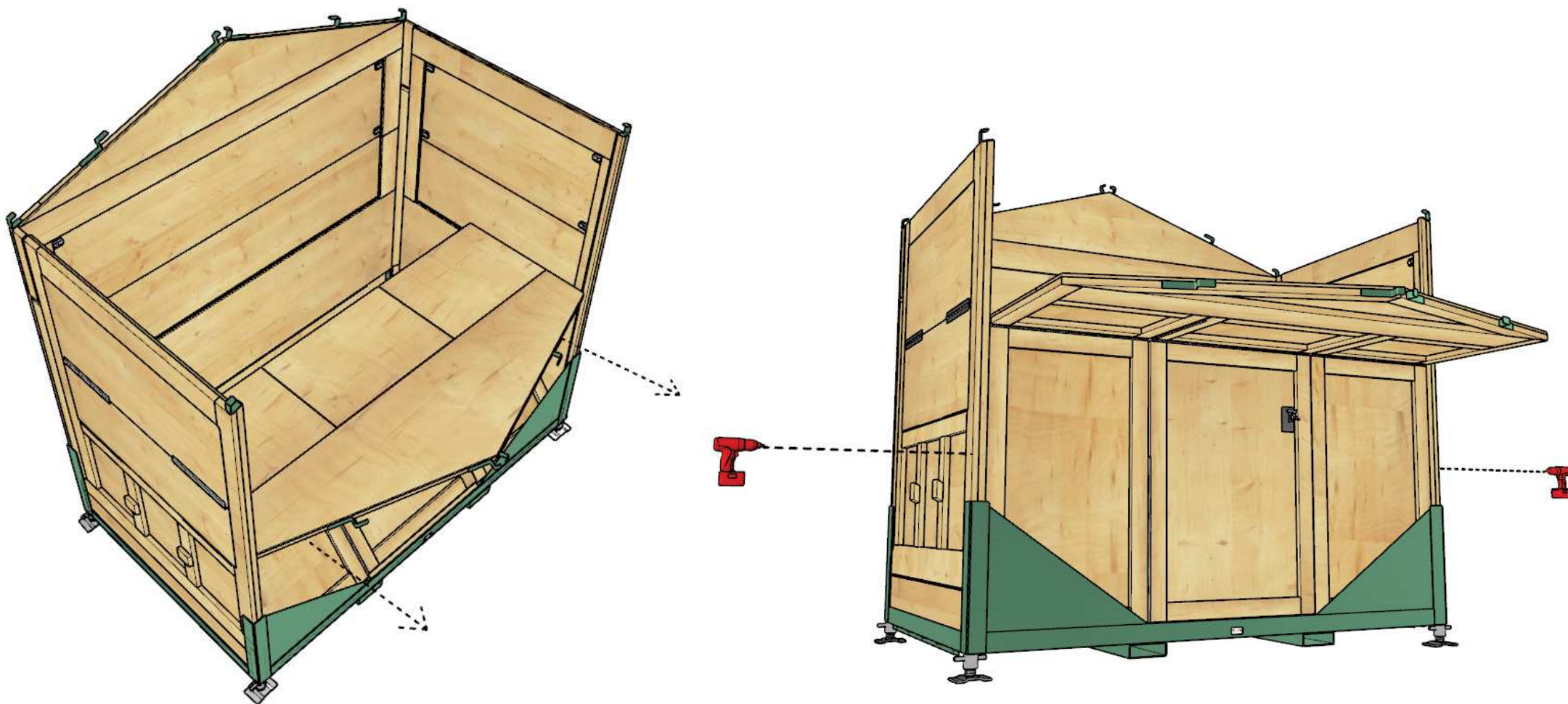

PORTARSI SUL LATO POSTERIORE DELLA CASSETTA. QUEST'ULTIMA E' COMPOSTA DA DUE PARTI INCERNIERATE TRA LORO. E' NECESSARIO IMPUGNARE LA PARTE TRIANGOLARE SUPERIORE E TIRARE VERSO L'ESTERNO DELLA CASSETTA IN MODO DA POSIZIONARE LA PARTE BASSA IN POSIZIONE VERTICALE COME MOSTRATO NELLA FIGURA A DESTRA. SONO RICHIESTI DUE OPERATORI PER IL COMPLETAMENTO DI QUESTA FASE. E' ORA POSSIBILE FISSARLA ALLE DUE PARETI LATERALI DESTRA E SINISTRA MEDIANTE LE VITI NEI FORI PREDISPOSTI (SONO PRESENTI DUE COPPIE DI FORI, UTILIZZARE LA COPPIA POSTA PIU' IN BASSO).

8



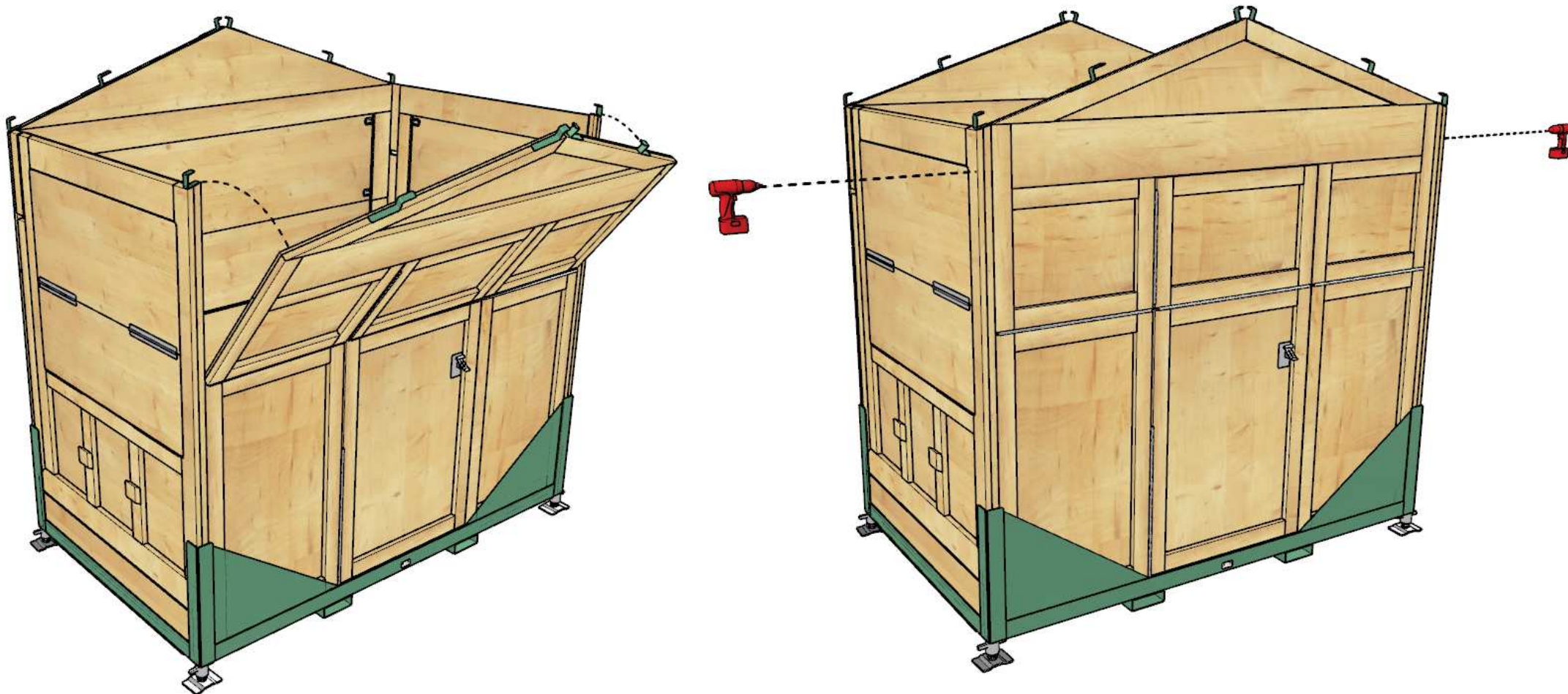

FAR RUOTARE LA SECONDA META' DELLA PARETE POSTERIORE PORTANDOLA IN POSIZIONE VERTICALE ALLINEANDOLA CON IL FILO ESTERNO DELLE DUE PARETI LATERALI. FISSARLA A QUESTE ULTIME MEDIANTE LE VITI IN DOTAZIONE UTILIZZANDO LA COPPIA DI FORI PREDISPOSTI POSTA PIU' IN ALTO SULLE PARETI DESTRA E SINSITRA COME MOSTRATO NELLA FIGURA DI DESTRA.

9





IL MONTAGGIO DELLE 4 PARETI E' ULTIMATO. SOLO ORA E' POSSIBILE PORTARE LA SERRATURA UN POSIZIONE DI SBLOCCO ED APRIRE LA PORTA D'INGRESSO, LA QUALE DEVE RIMANERE CHIUSA DA INIZIO MONTAGGIO FINO AL COMPLETAMENTO DI QUESTA FASE. PRESTARE ATTENZIONE IN FASE DI SMONTAGGIO, ASSICURANDOSI CHE LA PORTA SIA CHIUSA CON LA SERRATURA IN POSIZIONE DI BLOCCO DA QUESTO PUNTO IN POI. SI PUO' ORA PROCEDERE CON IL MONTAGGIO DELLA COPERTURA COME ESPLICATO NELLE FASI SUCCESSIVE.

10



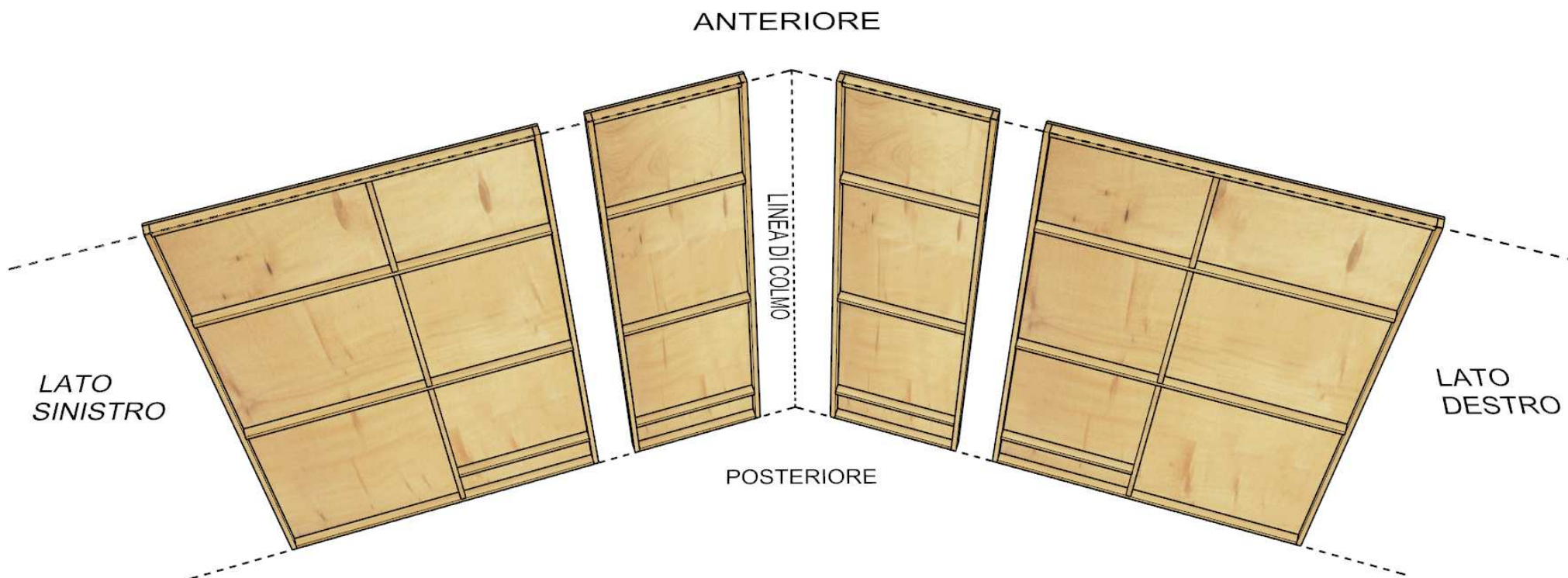

LA COPERTURA DELLA CASSETTA E' COMPOSTA DA 4 ELEMENTI, DUE FALDE GRANDI, POSTE AI DUE ESTREMI E SPECUALRI TRA LORO, E DUE PICCOLE, SPECULARI ANCH'ESSE, CHE DOVRANNO ESSERE POSIZIONATE IN CORRISPONDENZA DELLA LINEA DI COLMO. NELL'IMMAGINE SONO RAFFIGURATE IN UNA VISTA DAL BASSO VERSO L'ALTO: PRESTARE ATTENZIONE AL DISEGNO DEL TELAIO IN LEGNO PER LA LORO CORRETTA DISPOSIZIONE.

PRESTARE ATTENZIONE AL TAGLIO INCLINATO PRESENTE SU UNO DEI DUE LATI LUNGI DELLE COMPONENTI PICCOLE DELLA COPERTURA, QUESTO ANDRA' POSIZIONATO IN CORRISPONDENZA DELLA LINEA DI COLMO, MENTRE IL LATO LUNGO SENZA TAGLIO INCLINATO ANDRA' COLLOCATO DALLA PARTE OPPOSTA, A CONTATTO CON LA COMPONENTE GRANDE DELLA COPERTURA

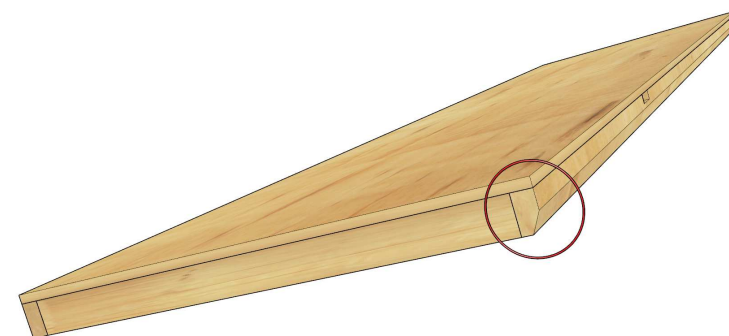

11



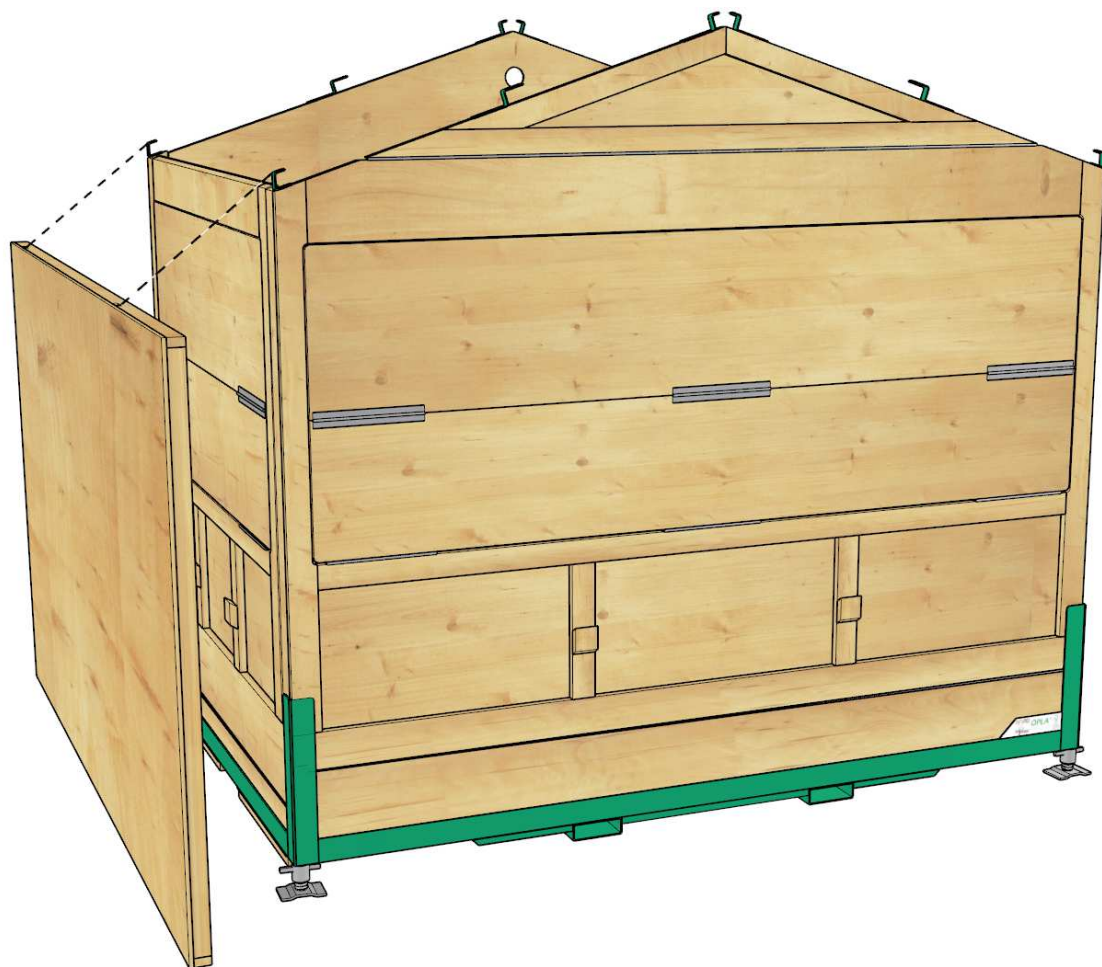

NELLE SEGUENTI FASI DI MONTAGGIO VERRA' RAFFIGURATA LA CASSETTA mod. MEDIUM, IL MONTAGGIO E' LO STESSO ANCHE PER IL MODELLO IN OGGETTO, mod. SMALL. MONTAGGIO DELLA FALDA GRANDE: SI PUO INZIARE INDISTINTAMENTE SIA DALLA FALDA DESTRA SIA QUELLA SINISTRA. POSIZIONARE LA FALDA CORRETTA (VEDI PUNTO 11) IN POSIZIONE VERTICALE COME MOSTRATO NELLA FIGURA , ALLINEANDO LE FRESATE (CONTORNATE DA UN RETTANGOLO ROSSO NELLA FIGURA DI DESTRA) NELLE QUALI ANDRANNO POI AD ALLOGGIARE I GANCI METALLICI FISSATI SUPERIORMENTE ALLE PARETI.

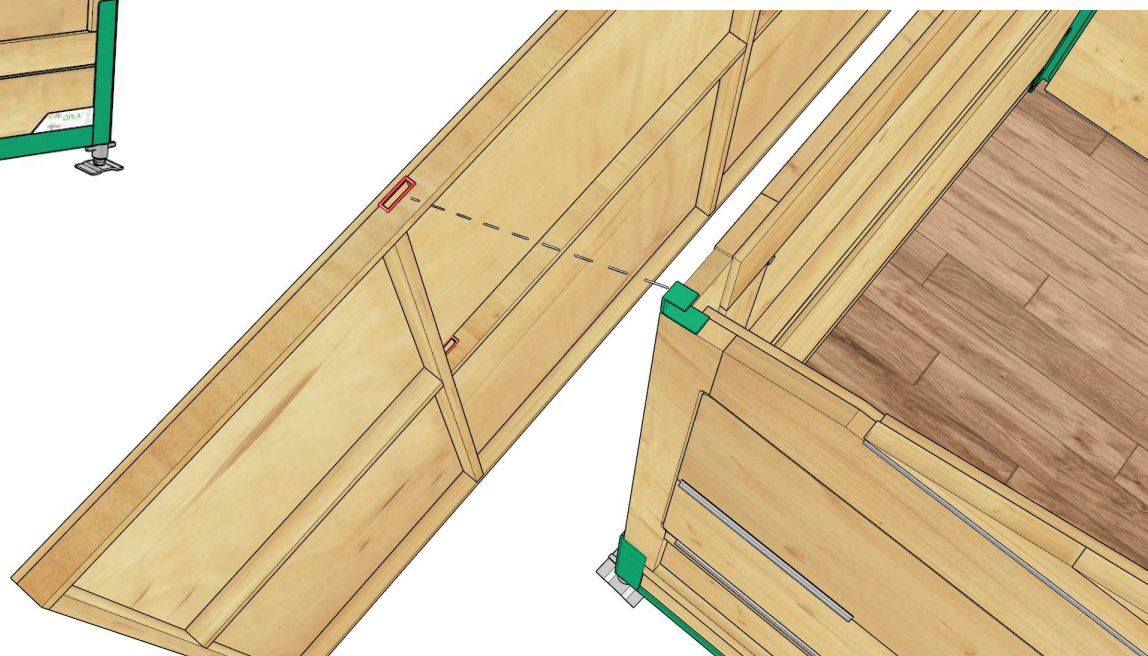

12



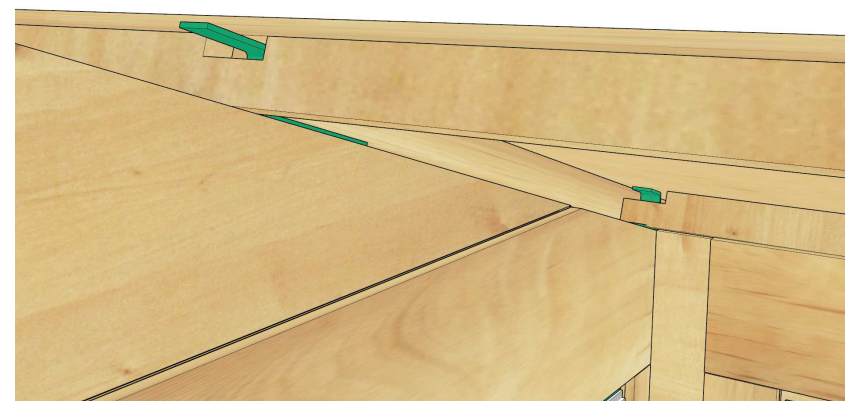
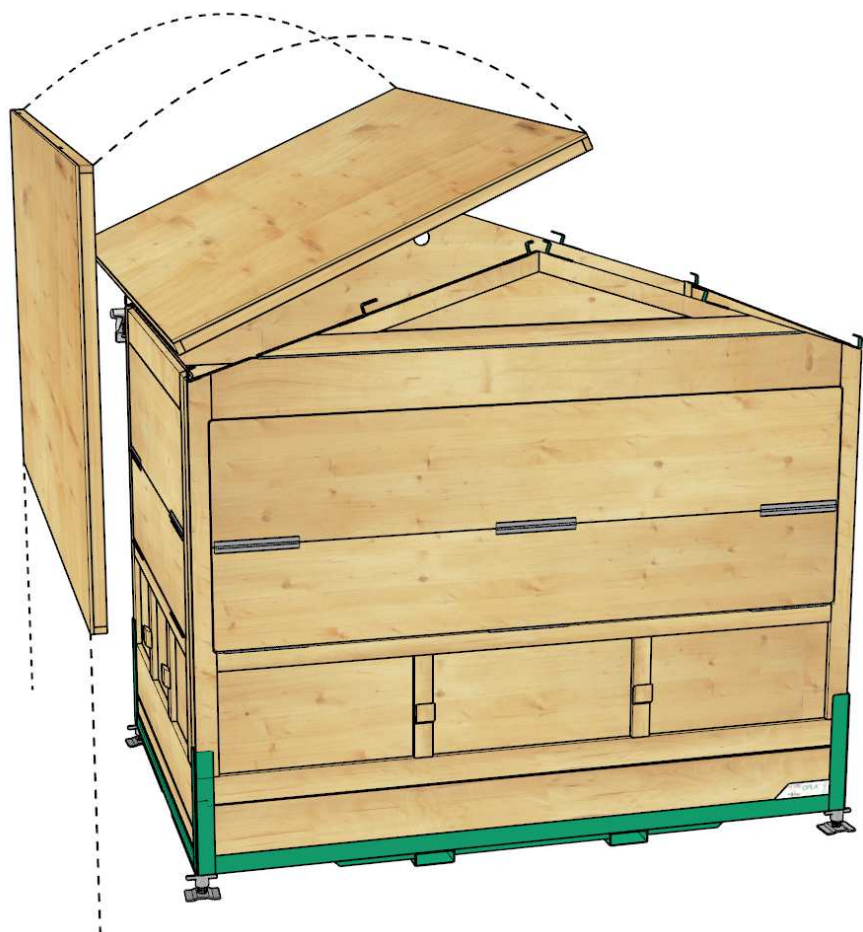

AFFERRARE LA COMPONENTE GRANDE DELLA COPERTURA SUL LATO DESTRO E SUL LATO SINISTRO DELLA STESSA, SOLLEVARLA VERTICALMENTE E FARLA SUCCESSIVAMENTE RUOTARE COME MOSTRATO IN FIGURA. REGOLANDO LA POSIZIONE DELLA FALDA IN MODO CHE I GANCI METALLICI FISSATI SUPERIORMENTE ALLE PARETI ANTERIORE E POSTERIORE DELLA CASSETTA VADANO A COLLOCARSI NELLE FRESATE PREDISPOSTE SULLA COPERTURA (COME MOSTRATO NEL DETTAGLIO DI DESTRA - VISTA DALL'INTERNO), TIRARE VERSO L'ESTERNO. RIPETERE LA STESSA OPERAZIONE CON LA FALDA GRANDE DESTRA O SINISTRA. SONO NECESSARI DUE OPERATORI PER QUEST'OPERAZIONE

13



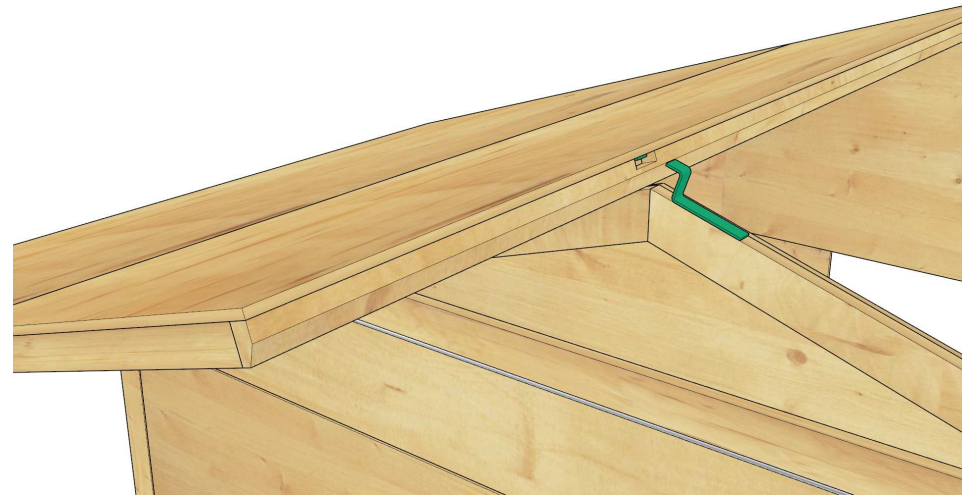
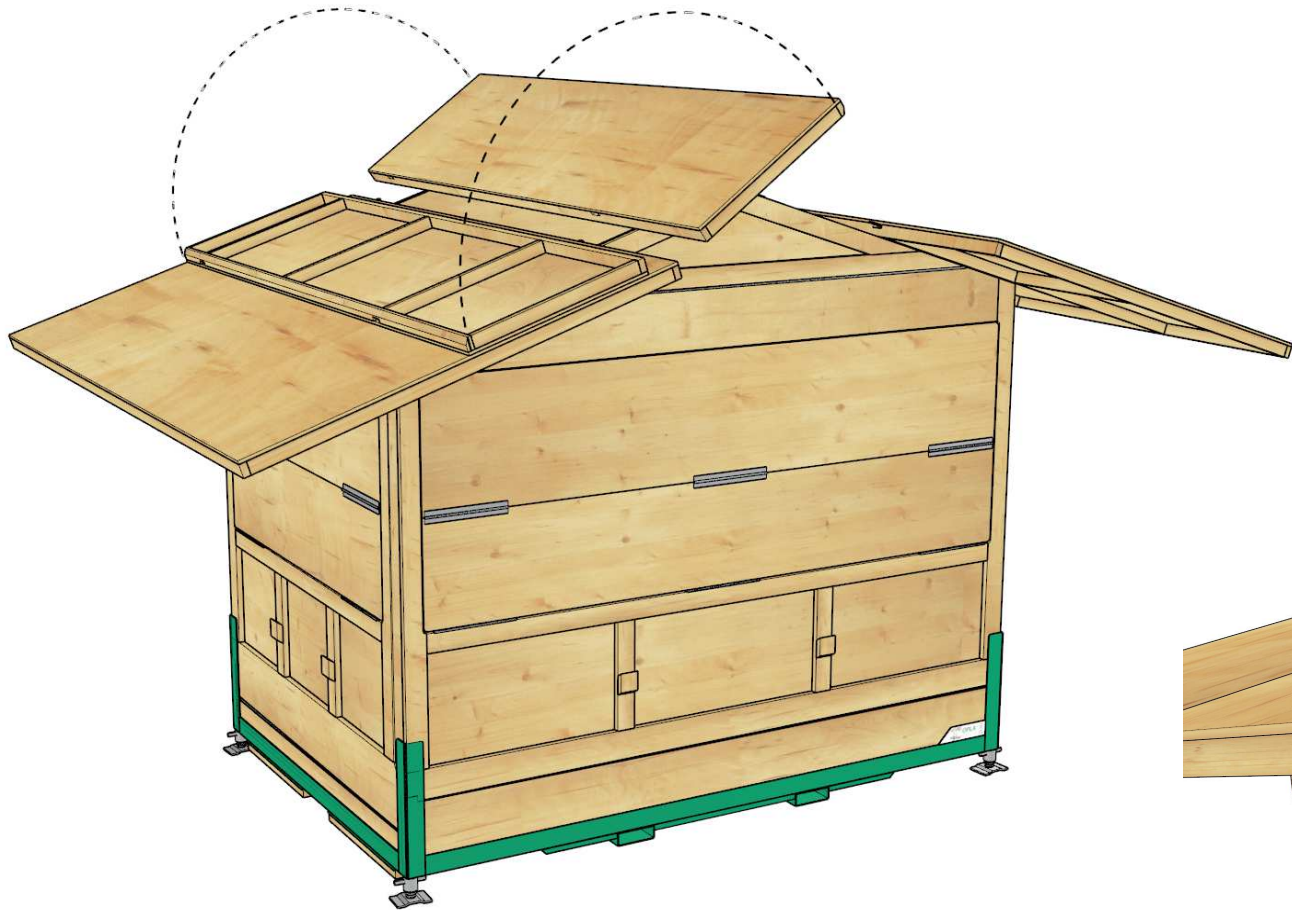

SONO NECESSARI DUE OPERATORI IN QUESTA FASE DI MONTAGGIO. AVVALENDOSI DELL'UTILIZZO DI DUE SCALE, POSTE UNA IN CORRISPONDENZA DEL LATO ANTERIORE ED UNA DI QUELLO POSTERIORE DELLA CASSETTA, POSIZIONARE LA FALDA PICCOLA, RELATIVA AL LATO DESTRO O SINISTRO, SOPRA QUELLA GRANDE PRECEDENTEMENTE MONTATA, CON IL TELAIO RIVOLTO VERSO L'ALTO, COME MOSTRATO IN FIGURA. LA TRAVE CON IL TAGLIO INCLINATO DI CUI AL PUNTO 11 DEVE ESSERE INIZIALMENTE RIVOLTA VERSO L'ESTERNO DELLA CASSETTA. AFFERRANDO LA COMPONENTE PICCOLA SIA DAL LATO ANTERIORE CHE POSTERIORE DELLA CASSETTA, FARLA RUOTARE COME MOSTRATO IN FIGURA, ASSICURARSI CHE I GANCI METALLICI FISSATI ALLE PARETI SIANO PERFETTAMENTE ALLOGGIATI NELLE FRESATE DEL TELAIO DI COPERTURA (FIGURA DI DESTRA) E CHE LA TRAVE CON IL TAGLIO INCLINATO SIA POSIZIONATA ORA IN CORRISPONDENZA DELLA LINEA DI COLMO. RIPETERE LA STESSA OPERAZIONE CON L'ELEMENTO DELLA COPERTURA MANCANTE.

14





E' ORA POSSIBILE DISPORRE IL TELO PROTETTIVO SOPRA LA COPERTURA IN LEGNO DELLA CASSETTA. POSIZIONARLO IN CORRISPONDENZA DELLA LINEA DI COLMO E APRIRLO LUNGO LE DUE FALDE. IL TELO DOVRA' ESSERE AGGANCIATO AL TELAIO DELLA COPERTURA, IN CORRISPONDENZA DEI SUPPORTI GIA' PREDISPOSTI, MEDIANTE GLI ELASTICI IN DOTAZIONE CHE, PER IL PRIMO MONTAGGIO, ANDRANNO ANNODATI IN CORRISPONDENZA DEGLI OCCHIELLI PRESENTI SUL TELO. TENSIONARE POI OGNI SINGOLO ELASTICO IN CORRISPONDENZA DEL RELATIVO SUPPORTO PER FISSARE CORRETTAMENTE IL TELO DI COPERTURA ALLA CASSETTA.

15





PER RENDERE OPERATIVA LA CASETTA NON RIMANE ALTRO CHE APRIRE I 3 BANCONI ESPOSITIVI SUI TRE LATI. PER FARE CIO' SONO NECESSARI DUE OPERATORI: UNO ALL'INTERNO, IL QUALE DOVRA APRIRE I 4 CATENACCI TRASVERSALI CHE TENGONO CHIUSI IN POSIZIONE VERTICALE OGNUNO DEI 3 BANCONI, IL SECONDO ALL'ESTERNO DOVRA' ACCOMPAGNARE LA ROTAZIONE DEI BANCONI FINO A CHE NON SARANNO ALLOGGIATI NEI RISPETTIVI SUPPORTI IN LEGNO, COME MOSTRATO IN FIGURA. LA CASETTA E' ORA PRONTA PER ESSERE UTILIZZATA.

16



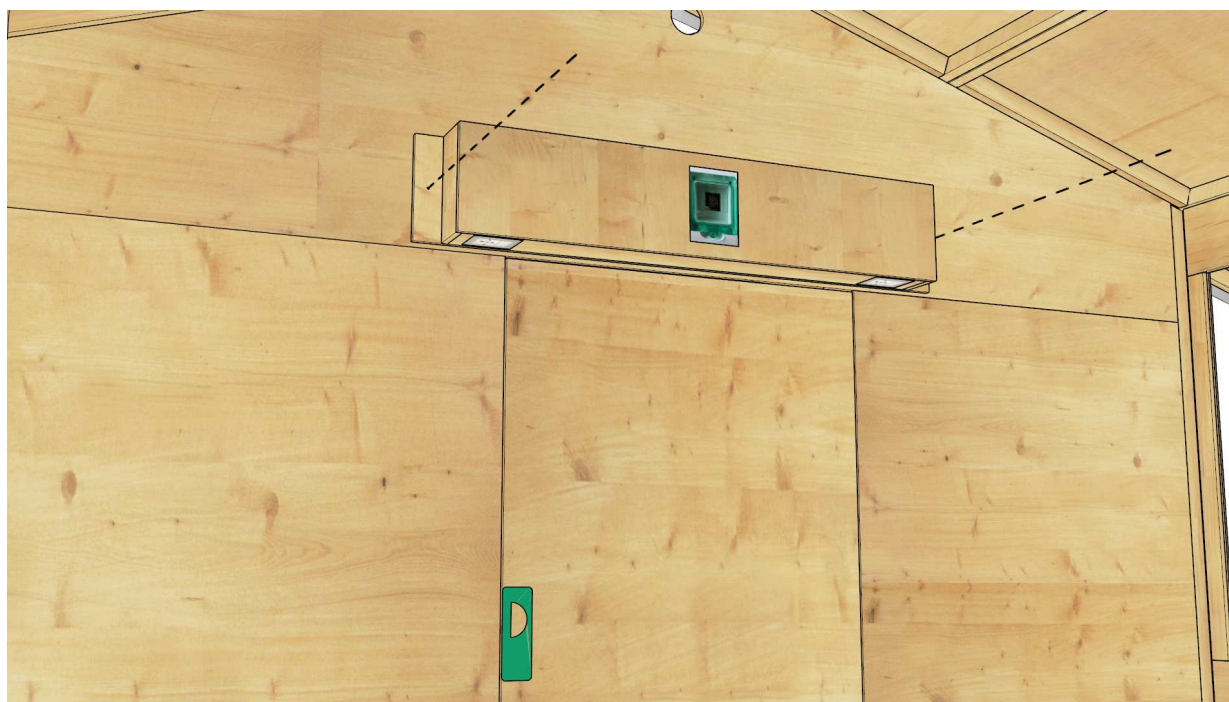
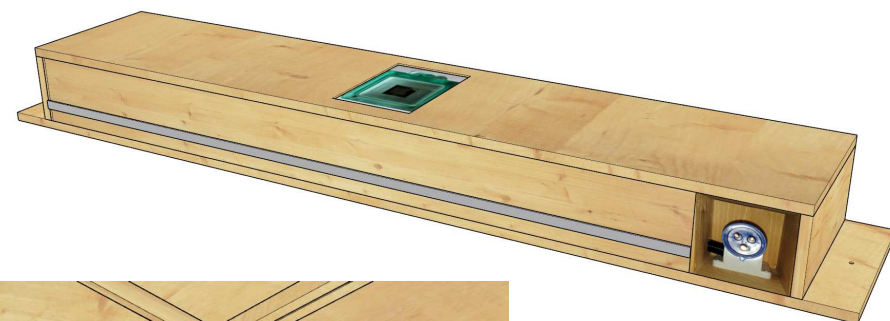
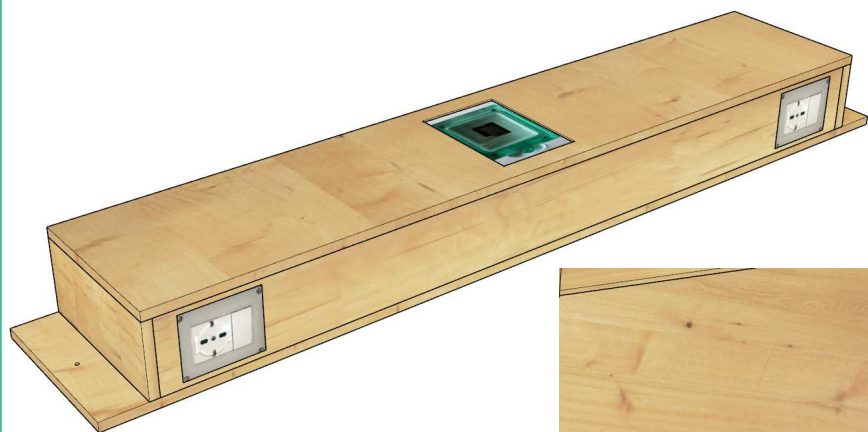

OPZIONALE: QUALORA SI FOSSE ACQUISTATO L'IMPIANTO ELETTRICO PER LA CASSETTA, QUESTO VA FISSATO ALL'INTERNO DELLA CASSETTA SULLA PARETE POSTERIORE IN CORRISPONDENZA DEL TRIANGOLO SUPERIORE COME MOSTRATO IN FIGURA, MEDIANTE I GALLETTI FORNITI ASSIEME ALL'IMPIANTO. AVVITARE COMPLETAMENTE I SUPPORTI IN CORRISPONDENZA DELLE BOCCOLE PREVISTE (LINEA TRATTEGGIATA NELLA FIGURA SOPRA), UNO SUL LATO SINISTRO ED UNO SUL LATO DESTRO. L'IMPIANTO ELETTRICO DEVE ESSERE FISSATO CON LA BARRA LED RIVOLTA VERSO L'ALTO E LE DUE PRESE RIVOLTE VERSO IL BASSO. E' SUFFICIENTE COLLEGARE ALLA RETE ELETTRICA L'IMPIANTO ATTRAVERSO L'APPOSITA PRESA PRESENTE SUL LATO SUPERIORE DELL'IMPIANTO PER POTERLO UTILIZZARE.

17



RAPID[®]

F O L D I N G • S Y S T E M S

MARKETED BY

Playground
by **NEW BRED SRL**